

**Critical Environment Technologies
Canada Inc.**

www.critical-environment.com

**Installation Manual for
AST-IS3**

**Infrared CO₂ Transmitter for with
Industrial Enclosure for mounting in ventilation ducts**



MANUAL REVISION-A, August 2017

**#145, 7391 VANTAGE WAY
DELTA, BC CANADA V4G 1M3
PH: 604-940-8741 TOLL FREE: 877-940-8741
www.critical-environment.com/blog**

IMPORTANT NOTE

Read and understand this manual prior to using this instrument. Carefully read the warranty policy, service policy, notices, disclaimers and revisions on the following pages.

This product must be installed by a qualified electrician or factory trained technician and according to instructions indicated in this manual. This instrument should be inspected and calibrated regularly by a qualified and trained technician.

This instrument has not been designed to be intrinsically safe. For your safety, **do not** use it in classified hazardous areas (explosion-rated environments).

INSTRUMENT SERIAL NUMBER:

PURCHASE DATE:

PURCHASED FROM:

WARRANTY POLICY

Critical Environment Technologies Canada Inc. (CETCI), also referred to as the manufacturer, warrants this instrument, (excluding sensors, battery packs, batteries, pumps and filters) to be free from defects in materials and workmanship for a period of **two years from the date of purchase from our facility**. The sensors have a warranty period of **one year on a pro-rated basis from the date of purchase from our facility**. If the product should become defective within this warranty period, we will repair or replace it at our discretion.

The warranty status may be affected if the instrument has not been used and maintained as per the instructions in this manual or has been abused, damaged, or modified in any way. This instrument is only to be used for purposes stated herein. The manufacturer is not liable for auxiliary interfaced equipment or consequential damage.

Due to ongoing research, development, and product testing, the manufacturer reserves the right to change specifications without notice. The information contained herein is based on data considered accurate. However, no warranty is expressed or implied regarding the accuracy of this data.

All goods must be shipped to the manufacturer by prepaid freight. All returned goods must be pre-authorized by obtaining a Returned Merchandise Authorization (RMA) number. Contact the manufacturer for a number and procedures required for product transport.

SERVICE POLICY

CETCI maintains an instrument service facility at the factory. Some CETCI distributors / agents may also have repair facilities; however, CETCI assumes no liability for service performed by anyone other than CETCI personnel.

Repairs are warranted for 90 days after date of shipment (sensors have individual warranties).

Should your instrument require non-warranty repair, you may contact the distributor from whom it was purchased or you may contact CETCI directly.

Prior to shipping equipment to CETCI, contact our office for an Returned Merchandise Authorization (RMA) number. All returned goods must be accompanied with an RMA number.

If CETCI is to do the repair work, you may send the instrument, prepaid, to:

Attention: Service Department
Critical Environment Technologies Canada Inc.
Unit 145, 7391 Vantage Way
Delta, BC, V4G 1M3

Always include your RMA number, address, telephone number, contact name, shipping / billing information, and a description of the defect as you perceive it. You will be contacted with a cost estimate for expected repairs, prior to the performance of any service work.

For liability reasons, CETCI has a policy of performing all needed repairs to restore the instrument to full operating condition.

Pack the equipment well (in its original packing if possible), as we cannot be held responsible for any damage incurred during shipping to our facility.

COPYRIGHTS

This manual is subject to copyright protection; all rights are reserved. Under international and domestic copyright laws, this manual may not be copied or translated, in whole or in part, in any manner or format, without the written permission of CETCI.

All software which CETCI utilizes and / or distributes holds a proprietary interest and is also subject to copyright protection and all rights are reserved. No party may use or copy such software in any manner or format, except to the extent that CETCI grants them a license to do so. **IF SOFTWARE IS BEING LOADED ONTO MORE THAN ONE COMPUTER, EXTRA SOFTWARE LICENSES MUST BE PURCHASED.**

DISCLAIMER

Under no circumstances will CETCI be liable for any claims, losses or damages resulting from or arising out of the repair or modification of this equipment by a party other

than CETCI service technicians, or by operation or use of the equipment other than in accordance with the printed instructions contained within this manual or if the equipment has been improperly maintained or subjected to neglect or accident. Any of the foregoing will void the warranty.

Under most local electrical codes, low voltage wires cannot be run within the same conduit as line voltage wires. It is CETCI policy that all wiring of our products meet this requirement.

It is CETCI policy that all wiring be within properly grounded (earth or safety) conduit.

REVISIONS

This manual was written and published by CETCI. The manufacturer makes no warranty or representation, expressed or implied including any warranty of merchantability or fitness for purpose, with respect to this manual.

All information contained in this manual is believed to be true and accurate at the time of printing. However, as part of its continuing efforts to improve its products and their documentation, the manufacturer reserves the right to make changes at any time without notice. Revised copies of this manual can be obtained by contacting CETCI or visiting www.critical-environment.com

Should you detect any error or omission in this manual, please contact CETCI at the following address:

Critical Environment Technologies Canada Inc.
Unit 145, 7391 Vantage Way, Delta, BC, V4G 1M3, Canada
Toll Free: +1.877.940.8741
Telephone: +1.604.940.8741
Fax: +1.604.940.8745
Email: marketing@cetci.com
Website: www.critical-environment.com

In no event will CETCI, its officers or employees be liable for any direct, special, incidental or consequential damages resulting from any defect in any manual, even if advised of the possibility of such damages.

AST-IS3 (no display)

AST-IS3 is a reliable, long life, infrared Carbon Dioxide (CO₂) analog transmitter that measures the concentration of carbon dioxide ventilation ducts. The enclosure cover has a built-in rubber gasket and all other connections must be tight and sealed to prevent water intrusion. Improper installation resulting in damage is not covered under warranty. The AST-IS3 can transmit data to a BAS system or controller and the standard CO₂ measurement range is 0—2,000 ppm.

Linear output functions are pre-programmed as CO₂ with jumper selected outputs 0 - 10V / 2 - 10V / 0 - 20mA / 4 - 20mA.

ITEM LOCATORS

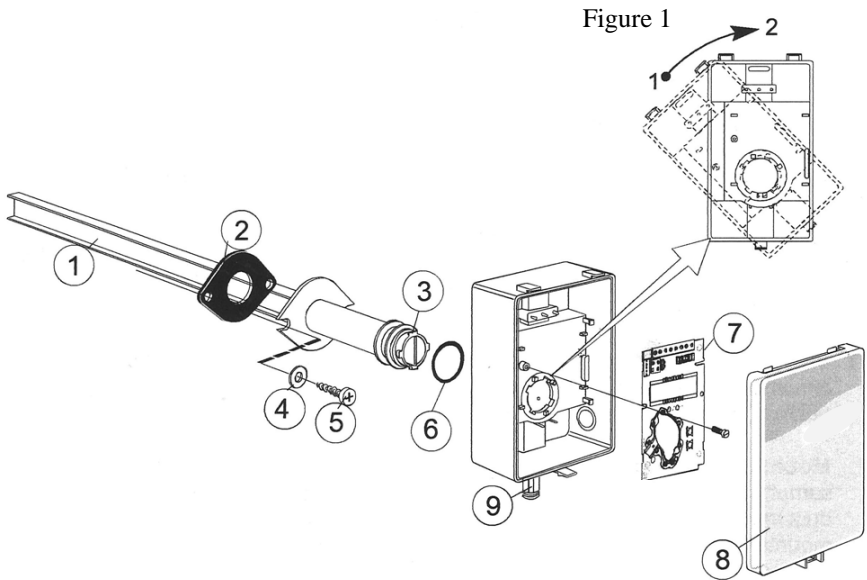

- 1 Sampling probe
- 2 Sealing gasket
- 3 Largest locking knob
- 4 2 washers BRB 5,3x10x1 (not included)
- 5 2 screws RXS 4,8x16 (not included)

- 6 O-ring 29,2x3,53
- 7 PCB
- 8 Snap-in lid
- 9 PG9 cable entry bushing

SPECIFICATIONS

AST-IS3

Measurement Range	0 - 2000 ppm
Power Supply	24 VDC or VAC, 50/60 Hz (half-wave rectifier input)
Power Consumption	<1 W average
Linear Output	0-10 VDC or 0-20 mA 2-10 VDC or 4-20 mA
Temperature Sensor Range	No temperature sensor
Accuracy	na
Operating Temperature	0°C to 50°C (32°F to 122°F)
Operating Humidity	0—85% RH non-condensing
Display	No
Enclosure Rating	IP54 rated
Dimensions	152 x 85 x 47 mm 5.98 x 3.34 x 1.85 inches
Alarm	No
Mute button	No
Relay Output	No
Mounting Type	Duct mount
Probe length	245 mm / 9.6 inches
Communication	Analog
Certifications	CE and EMC

This product is in accordance with EMC 2004/108/EC, 92/31/EEG including amendments by the CE-marking Directive 93/68/EEC.

This product fulfills the following demands:
EN 61000-4-2 Level 2, EN 61000-4-3 Level 2, EN 61000-4-4 Level 4, EN 61000-4-6,
EN 61000-4-8 Level 4, EN 55022 Class B



KEY FEATURES:

- State of the art non-dispersive infrared (NDIR) technology to measure carbon dioxide gas
- Maintenance free in normal applications
- Membrane covered sample chamber for a stable, reliable and highly accurate carbon dioxide sensor
- Fully coated PCB together with a special filter equipped housing for resistance towards dust and humidity
- Two programmable analog outputs

DUCT MOUNTING INSTRUCTIONS

If cover must be removed for any reason, loosen single securing screw on bottom of enclosure, press tab to release cover and hinge upward to remove.

Normally the PCB should not be removed from the housing. If for some reason the PCB must be removed it must be handled carefully and protected from electrostatic discharge.

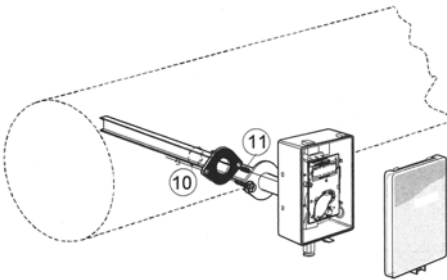



Since there might be a substantial pressure difference in duct mounting applications, it is essential to avoid ambient air from suction into the duct mounting box. For correct function, it is indispensable that the seals of the box cover, the cable entry bushings, the cable feed through and the duct entrance are absolutely tight. The duct entrance may need extra sealing paste in order to prevent leakage.

- 1) **Electrical cable entry:** The box has a factory mounted cable entry bushing in dimension PG9, item-9 in drawing on previous page. Never feed more than one cable through each cable entry bushing, or else gas might leak through.
- 2) **Mounting the tube:** Drill a hole with 25 mm diameter (or 1 inch) for the sampling probe and two holes with 4 mm diameter for the screws into the air duct and mount the tube with the gasket. The sampling probe should be mounted with the largest locking nob on top. The unit can be mounted with the air coming from the left or the right.
- 3) **Attaching the sensor box:** The sampling probe attaches to the sensor box by a snap-in bayonet fitting. Orient the box onto the sampling probe so that the box upside is on the same side as the largest locking knob. When the probe is fitted into the notches of the box, turn the box clockwise until it stops upright. See Figure 1: Position 1 indicates open where the box can be removed from the sampling probe. Position 2 the box is locked to the probe.



If for some reason the PCB must be removed it must be handled carefully and protected from electrostatic discharge! Normally, re moving the PCB is not required.



ELECTRICAL CONNECTIONS

The power supply has to be connected to  and .  is considered as system ground.

NOTE: The same ground reference has to be used for the AST-IS3 and for the control system.

If possible keep the sensor powered up after mounting. Connect analog output before measuring.



TERMINAL	FUNCTION	ELECTRICAL DATA	REMARKS
	Power (+)	24VAC/DC + (+20%), 2W	
	Power Ground (-)	24VAC/DC -	System voltage reference
Out1	Analog Output - 1 (+)	0-10 VDC or 0-20 mA 2-10 VDC or 4-20 mA	0-2000 ppm CO2
Out2	Analog Output - 2	Same as Out1 0.9 - 1.6 VDC or 1.5 - 2.5 mA 0 VDC or 0 mA	0-2000 ppm CO2 Status = Error Status = NOT READY

The AST-IS3 can deliver a voltage or a current loop for OUT1 and OUT2. To change between voltage and current output mode the hardware jumpers are used. There is one jumper for OUT1 and one jumper for OUT2, so that one output can be a voltage output and the other a current output. Both voltage output and current output can have start points 0% (0-10 VDC or 0-20mA) or 20% (2-10VDC or 4-20mA). The same start point jumper is used for both outputs.

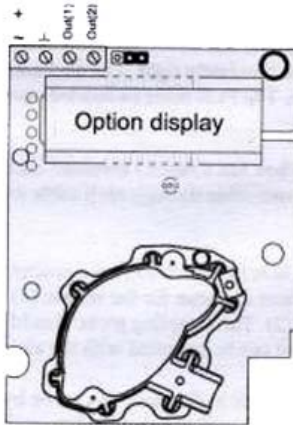
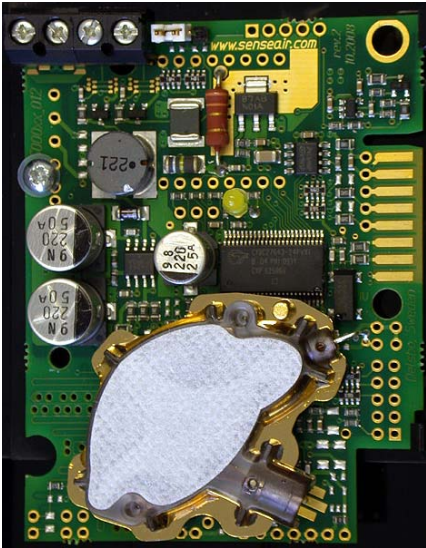

Figure 2 PCB with jumper to configure OUT2 for current output 4-20mA or voltage output 2-10VDC

WIRING TERMINALS & SIGNAL OUTPUT JUMPER SETTINGS



- + \sim POWER 24VAC / DC+
- \perp POWER GROUND (-)
- OUT-1 ANALOG OUT 4-20 mA(+)
- OUT-2 ANALOG OUT 0-10VDC(+)
- CURRENT OUTPUT JUMPER SET
- VOLTAGE OUTPUT JUMPER SET

NOTE: JUMPER IN THIS PHOTO IS SET FOR VOLTAGE OUTPUT. FOR CURRENT OUTPUT, COVER THE TWO PINS CLOSEST TO THE TERMINAL STRIP.
 <<<<

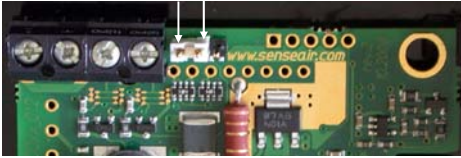

The drawings below indicate the jumper locations and positions for attaining current or voltage output

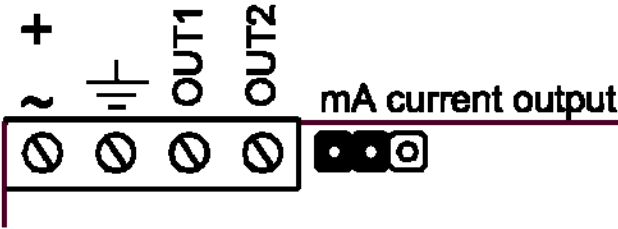

Drawing of PCB jumper area with the jumper set to current output (left position)

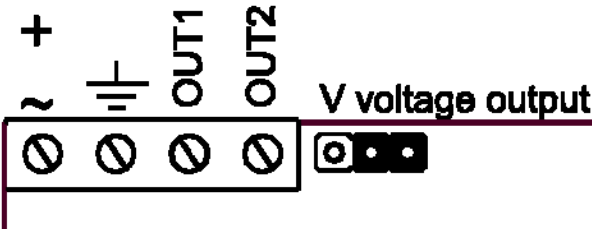

Drawing of PCB jumper area with the jumper set to voltage output (right position)

DIMENSIONS

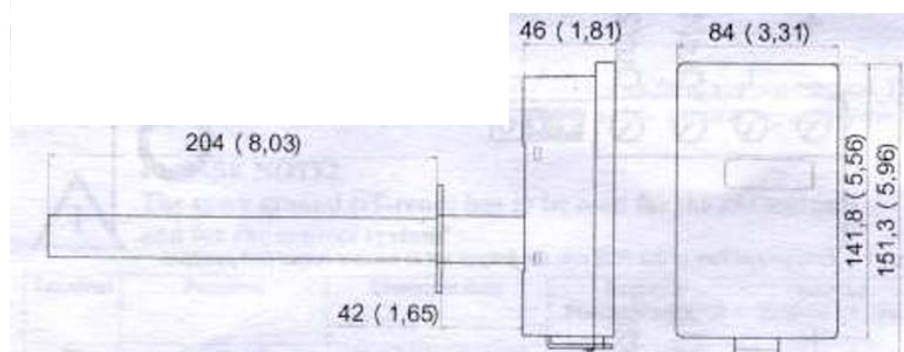

Figure 5. The dimensions of the sensor in mm and (inches)

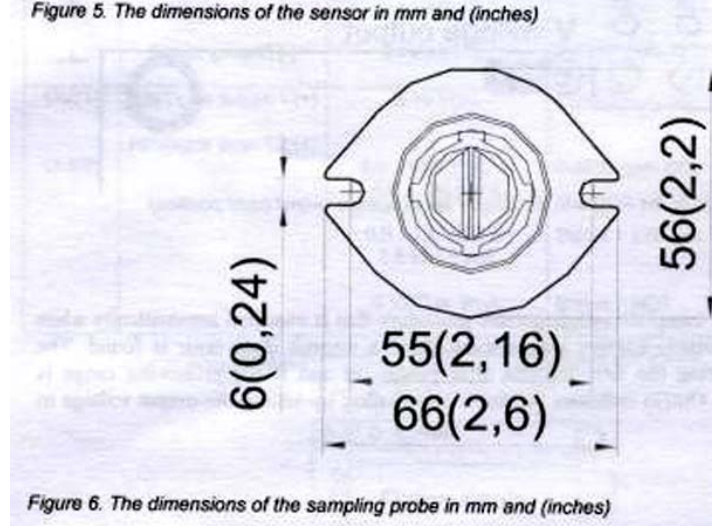

Figure 6. The dimensions of the sampling probe in mm and (inches)

Critical Environment Technologies Canada Inc.

Unit 145, 7391 Vantage Way, Delta, BC, V4G 1M3, Canada

Toll Free: +1.877.940.8741

Tel: +1.604.940.8741

Fax: +1.604.940.8745

www.critical-environment.com

